



## PD300-TO25-FW-2pin Series

### Features:

- Large active area convenient for optical coupling
- Low Dark Current
- Respond to C-Band and 1310nm; L-Band
- High reliability

### Applications:

- Near infrared sensors
- Laser diode and LED power monitor
- Near infrared spectroscopy
- Optical measurements and sensing

### Specifications:

#### Absolute Maximum Ratings:

Parameter	Symbol	Min.	Max.	Unit
Reverse Voltage	$V_R$	—	20	V
Forward Current	$I_F$	—	50	mA
Max. Optical Input Power	$P_{MAX}$	—	30	mW
Operating Temperature	$T_{op}$	-40	+85	°C
Storage Temperature	$T_{stg}$	-40	+85	°C
Lead Solder Temperature	—	—	260	°C
Lead Solder Time	—	—	10	s

#### Characteristics: ( $T_a=25^\circ\text{C}$ unless otherwise noted)

Parameter	Symbol	Test Conditions	Min.	Typ.	Max.	Unit	
Active Diameter	D	—	—	300	—	$\mu\text{m}$	
Bandwidth	BW	$P_i=-10\text{dBm}$ , Small signal modulation, $V_R=5\text{V}$	400	600	—	MHz	
Responsivity	@1310nm	R	$V_R=5\text{V}$	0.8	0.9	—	A/W
	@1550nm	R	$V_R=5\text{V}$	0.9	0.95	—	A/W
Dark Current	$I_D$	$V_R=5\text{V}$	—	0.1	0.6	nA	
Chip Capacitance	$C_{chip}$	$V_R=5\text{V}$ , $f=1\text{MHz}$	—	4.0	6.0	pF	
Optical Spectrum Response Range	$\lambda$	—	1100	—	1620	nm	



Operating Voltage	V	—	—	-5.0	—	V
-------------------	---	---	---	------	---	---

### Mechanical Dimension and Pin Assignment:

#### Type A

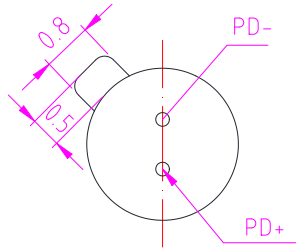

Bottom View

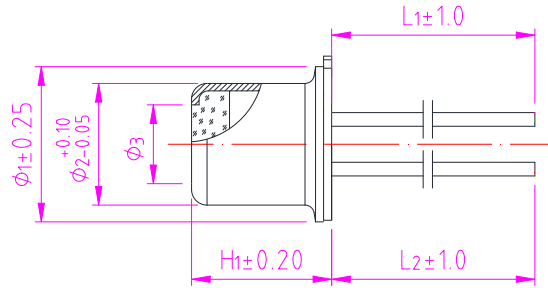

#### Type B

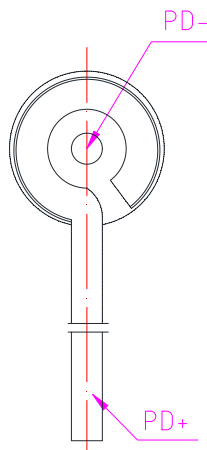

Bottom View

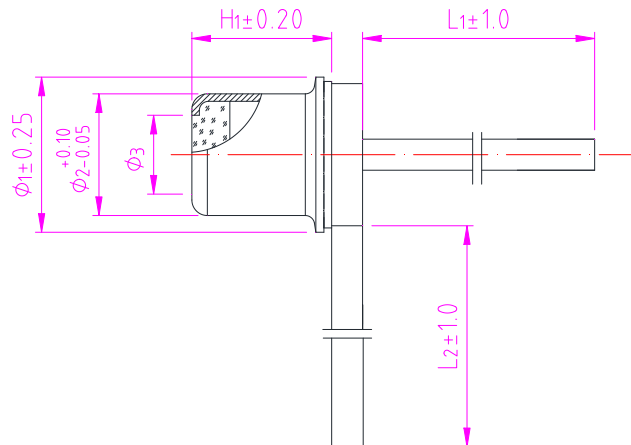

#### Type C

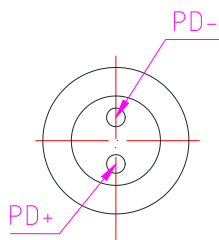

Bottom View

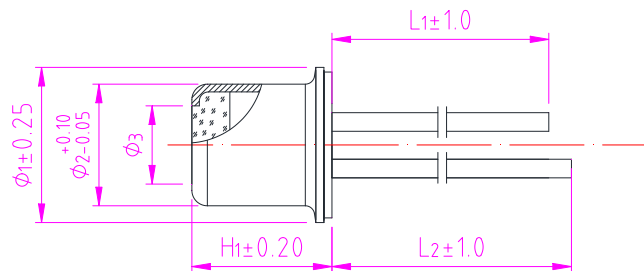



### Standard Product List:

Product name	$\Phi_1$ (mm)	$\Phi_2$ (mm)	$\Phi_3$ (mm)	$H_1$ (mm)	$L_1$ (mm)	$L_2$ (mm)	Received light form
PD300-TO25-FW-2pin-A	2.5	1.96	1.27	2.26	12.7	12.7	Parallel light & Divergent light
PD300-TO25-FW-2pin-B	2.5	1.96	1.27	2.26	14.0	14.0	
PD300-TO25-FW-2pin-C	2.5	1.96	1.27	2.26	15.52	17.52	

- Standard and custom designs to suit your systems.

### Order Information:

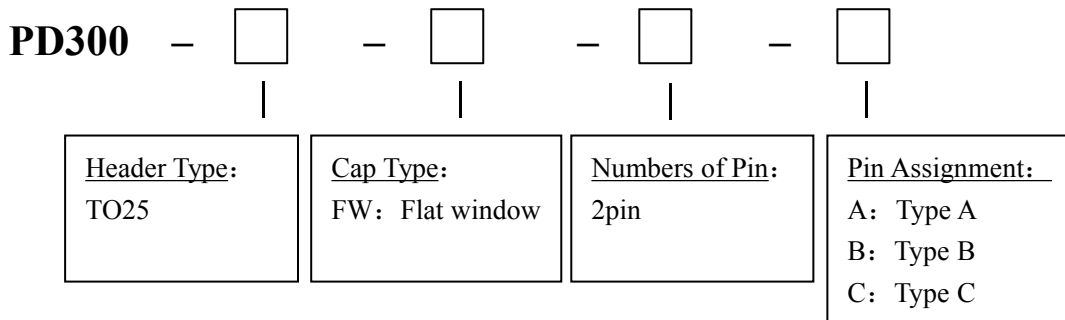

### Statement:

SAN-U owns the authority for final explanation of all information contained in this document, which is subject to change without notice. All the information was obtained in particular environments; and SAN-U will not be responsible for the performance of the customers' actual operating environments. All information contained is only for the users' reference and shall not be considered as warranted characteristics. SAN-U will not be liable for damages arising directly or indirectly which from any use of the information contained in this document.

### Contact Information:

Address: N501-505 Weiye Bldg., Xiamen Pioneering Park For Overseas Chinese Scholars, Xiamen, Fujian, China

Tel: +86-592-3898601, 3898608, 5318000

Fax: +86-592-5703588

Email: [sales@san-u.com](mailto:sales@san-u.com)

<http://www.san-u.com>