



PD60-TO25-BL-2pin Series

Features:

- Low Voltage Operation
- Low Capacitance and High Speed with a PIN Structure
- Low Dark Current
- Excellent Stability

Applications:

- Digital and Analog Optical Communication
- Optical LAN
- OTDR

Specifications:

Absolute Maximum Ratings:

Parameter	Symbol	Min.	Max.	Unit
Reverse Voltage	V_R	—	20	V
Forward Current	I_F	—	5	mA
Max. Optical Input Power	P_{MAX}	—	5	mW
Operating Temperature	T_{op}	-40	+85	°C
Storage Temperature	T_{stg}	-40	+85	°C
Lead Solder Temperature	—	—	260	°C
Lead Solder Time	—	—	10	s

Characteristics: ($T_a=25^{\circ}\text{C}$ unless otherwise noted)

Parameter	Symbol	Test Conditions	Min.	Typ.	Max.	Unit	
Active Diameter	D	—	—	60	—	μm	
Bandwidth	BW	$V_R=5\text{V}$	3	—	—	GHz	
Responsivity	@1310nm	R	$V_R=5\text{V}$	0.8	0.9	—	A/W
	@1550nm	R	$V_R=5\text{V}$	0.9	0.95	—	A/W
Dark Current	ID	$V_R=5\text{V}$	—	0.2	1.0	nA	
Chip Capacitance	C_{chip}	$V_R=5\text{V}, f=1\text{MHz}$	—	0.45	0.5	pF	
Optical Spectrum Response Range	λ	—	1100	—	1620	nm	
Operating Voltage	V	—	—	-5	—	V	



Mechanical Dimension and Pin Assignment:

Type A

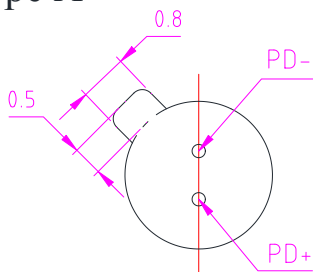

Bottom View

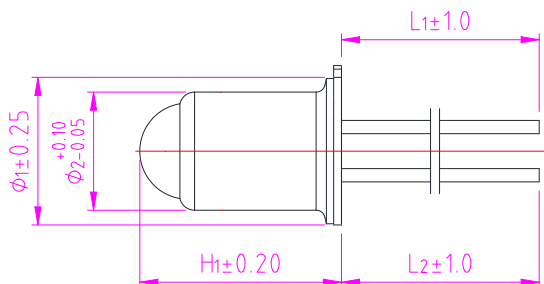

Type B

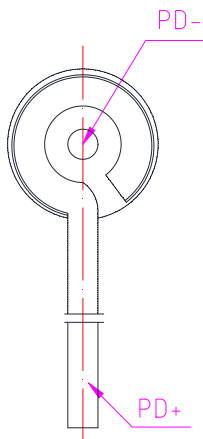

Bottom View

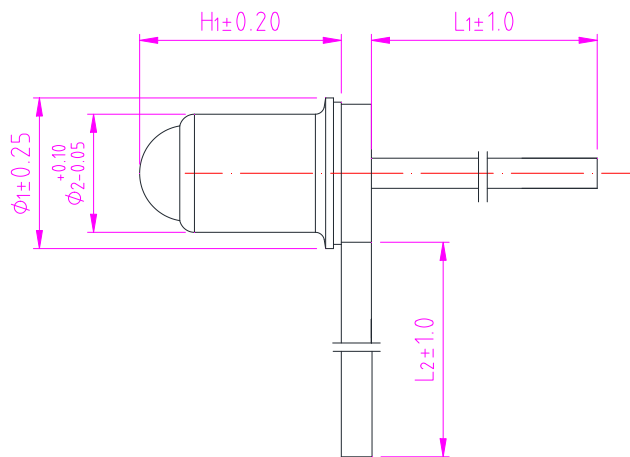

Type C

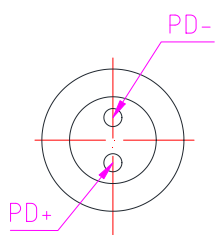

Bottom View

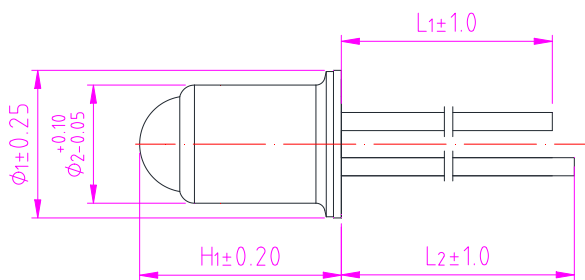



Standard Product List:

Product name	Φ_1 (mm)	Φ_2 (mm)	H ₁ (mm)	L ₁ (mm)	L ₂ (mm)	Received light form
PD60-TO25-BL(High)-2pin-A	2.5	1.96	3.35	12.7	12.7	Divergent light
PD60-TO25-BL(High)-2pin-B	2.5	1.96	3.35	14.0	14.0	
PD60-TO25-BL(High)-2pin-C	2.5	1.96	3.35	15.52	17.52	
PD60-TO25-BL(Short)-2pin-A	2.5	1.96	2.92	12.7	12.7	Parallel light
PD60-TO25-BL(Short)-2pin-B	2.5	1.96	2.92	14.0	14.0	
PD60-TO25-BL(Short)-2pin-C	2.5	1.96	2.92	15.52	17.52	

- Standard and custom designs to suit your systems.

Order Information:

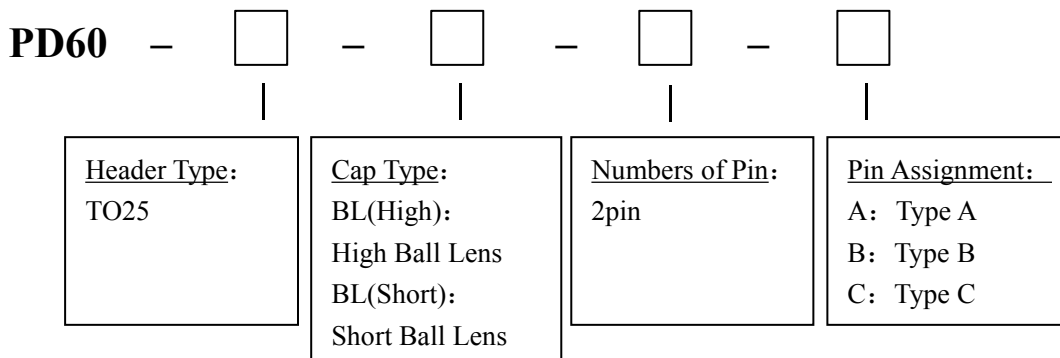

Statement:

SAN-U owns the authority for final explanation of all information contained in this document, which is subject to change without notice. All the information was obtained in particular environments; and SAN-U will not be responsible for the performance of the customers' actual operating environments. All information contained is only for the users' reference and shall not be considered as warranted characteristics. SAN-U will not be liable for damages arising directly or indirectly which from any use of the information contained in this document.

Contact Information:

Address: N501-505 Weiye Bldg., Xiamen Pioneering Park For Overseas Chinese Scholars, Xiamen, Fujian, China

Tel: +86-592-3898601, 3898608, 5318000

Fax: +86-592-5703588

Email: sales@san-u.com

<http://www.san-u.com>